

Alle Rechte vorbehalten / all rights reserved © Telegärtner K.Gärtner GmbH D-71144 Steinbronn Leichenstrasse 35 Germany Phone: +49 7157/125-0 Fax: +49 7157/125-120 www.telegaertner.com

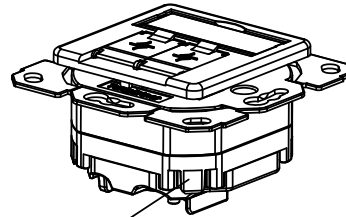
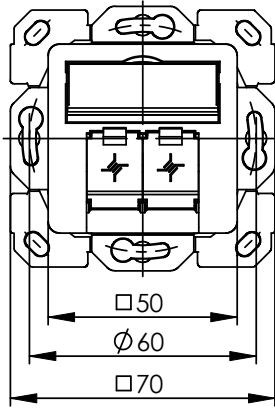
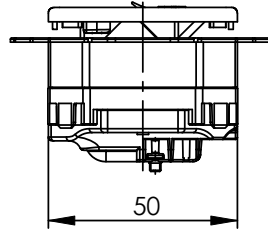
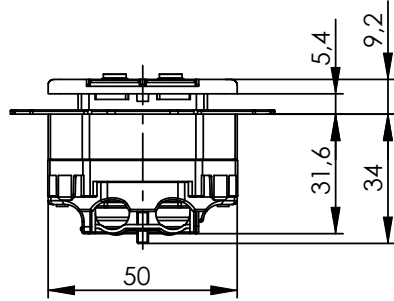

4 x Flachstecker 6,3 mm DIN46342-1  
für Funktionserdung IEC60364-5-548  
4 x blade terminal 6,3 mm DIN46342-1  
for functional earthing acc. to IEC60364-5-548

Bestell-Nr.: Order Nr.:	Bezeichnung: Description:	Farbe: Colour:	RAL:
J00020A0389	AMJ45 8/8 UP/50 Cat.5e	alpinweiß / alpine white	
J00020A0390	AMJ45 8/8 UP/50 Cat.5e	perlweiß / pearl white	RAL 1013
J00020A0388	AMJ45 8/8 UP/0 Cat.5e ohne Zentralplatte / without face plate		
J00020A0419	AMJ45 8 UP/50 Cat.5e	alpinweiß / alpine white	
J00020A0418	AMJ45 8 UP/50 Cat.5e	perlweiß / pearl white	RAL 1013
J00020A0420	AMJ45 8 UP/50 Cat.5 ohne Zentralplatte / without face plate		

Verpackung	Packing
Trennbare 5 x 1-er Verpackung mit Montageanleitung.	separable 5 x 1 packaging with mounting instructions
Montageanleitung siehe	www.telegaertner.com Mounting instructions see

Optional  
Staubschutzklappen sind in unterschiedlichen Farben erhältlich und können separat bestellt werden.  
Dust protection flaps are available in different colours and can be ordered separately.

Maßstab / scale 1:1

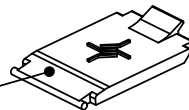

Bestell-Nr.: Order Nr.:	Bezeichnung: Description:	Farbe: Colour:	RAL:	Verpackung: Packing:
B00002A0014	Staubschutzklappe / Dust protection flap	alpinweiß / alpine white		10 Stück / 10 Pieces
B00002A0015	Staubschutzklappe / Dust protection flap	perlweiß / pearl white	RAL 1013	10 Stück / 10 Pieces
B00002B0014	Staubschutzklappe / Dust protection flap	rot / red	RAL 3020	100 Stück / 100 Pieces
B00002C0014	Staubschutzklappe / Dust protection flap	grün / green	RAL 6017	100 Stück / 100 Pieces
B00002D0014	Staubschutzklappe / Dust protection flap	blau / blue	RAL 5015	100 Stück / 100 Pieces
B00002E0014	Staubschutzklappe / Dust protection flap	gelb / yellow	RAL 1023	100 Stück / 100 Pieces
B00002F0014	Staubschutzklappe / Dust protection flap	schwarz / black	RAL 9005	100 Stück / 100 Pieces

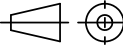
a	20905	27.05.09	BM	2008	Datum/ date	Name/ name	Gewicht/ weight [g]	Oberfläche/ surface [mm²]	Werkstoff/ material
				gez./ drawn	05.11.08	BM			
				gepr./ appr.	01.12.08	HI			Oberfläche/ finish
				Norm/ stand.					
				Maßstab/ scale	Benennung/ title				 <b>Telegärtner</b>
				1:2 (1:1)	Anschlussdose / Outlet AMJ45 8/8 UP/50 Cat.5e				
				untol. Maße/ dim. without tolerances according to	Unterf./doc. type	Zeichnungsnr./ drawing no.			
					D	J00020A0389			
					Ersatz für/ replaces				
									 Maße/ dimensions: mm
									Original : DIN A4
									Blatt/ sheet 1 von/ of 3

## Technische Daten / Technical Data

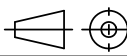

<b>Steckverbinder-Norm</b>	IEC 60603-7-3	<b>Connector standard</b>
<b>Mechanische Eigenschaften</b>		<b>Mechanical Characteristics</b>
Steckkraft	≤ 30N	Insertion force
Lebensdauer (Steckzyklen RJ45 ,RJ12, RJ11)	≥ 750	Life (mating cycles RJ45, RJ12, RJ11)
<b>Werkstoffe</b>		<b>Materials</b>
Abschirmgehäuse	Zinkdruckguss / zinc diecast	Shielding housing
Isolierplatte	PA schwarz / black	Insulating plate
Zentralplatte	ABS	Face plate
Staubschutzklappe	ABS	Dust protection flap
Klarsichtabdeckung	PC	Transparent cover
Kabelklemme	Stahl verzinkt / steel zinc plated	Cable clamp
Schraube	Stahl verzinkt / steel zinc plated	Screw
Leiterplatte	FR4	PCB
Oberfläche Leiterplatte	verzinkt / tin-plated	PCB finish
Buchsengehäuse	PBT weiß / white	Jack housing
Schirmblech	Neusilber / German silver	Shield
Kontaktfeder	CuSn	Contact spring
Oberfläche Kontaktfeder	min. 1,3 µm Au über / on 2 µm Ni	Contact spring finish
LSA-Gehäuse	PBT UL94 V0 weiß / white	IDC housing
Schneidklemmkontakte	CuZn	IDC
Oberfläche Schneidklemmkontakte	verzinkt / tin-plated	IDC inish
LSA-Plus Cu-Leiterdurchmesser	massiv / solid 0,4-0,65mm AWG26/1 - AWG 22/1	LSA-Plus Cu-conductor diameter
Aderndurchmesser	0,7 - 1,6mm	Insulation diameter
Wiederanschließbarkeit Schneidklemmkontakt	≤ 50x	Reusable IDC
EG Richtlinie 2002/95/EG (RoHS)	RoHS-konform / RoHS-compliant	EC Directive 2002/95/EC (RoHS)
<b>Umweltanforderungen</b>		<b>Environmental Requirements</b>
<b>Schutz vor Eindringen</b>		<b>Protection against ingress</b>
Eindringen von Teilchen	IP2X	Particulate ingress
Wasser/Untertauchen	IPX0	Water / Immersion
<b>Klimatisch und chemisch</b>		<b>Climatical and chemical</b>
Umgebungstemperatur	-40°C bis / to +70°C	Ambient temperature
<b>Elektrische Eigenschaften</b>		<b>Electrical Characteristics</b>
Kontaktwiderstand	≤ 20 mΩ	Contact resistance
Isolationswiderstand	≥ 500 MΩ	Insulation resistance
<b>Spannungsfestigkeit</b>		<b>Voltage proof</b>
Kontakt-Kontakt	≥ 1000 V, DC	Contact-contact
Kontakt-Schirm	≥ 1500 V, DC	Contact-shield
<b>Strombelastbarkeit bei 50°C</b>	1 A	<b>Current carrying capacity at 50°C</b>
<b>PoE gemäß IEEE 802.3af</b>	Geeignet für Power over Ethernet Adequate for Power over Ethernet	<b>PoE according to IEEE802.3af</b>
<b>Transfer-Impedanz</b>		<b>Transfer Impedance</b>
bei 1 MHz	≤ 100 mΩ	at 1 MHz
bei 10 MHz	≤ 200 mΩ	at 10 MHz
bei 80 MHz	≤ 1600 mΩ	at 80 MHz

Alle Rechte vorbehalten / all rights reserved © Telegärtner K.Gärtner GmbH D-71144 Steinenbronn Leichenstrasse 35 Germany Phone: +49 7157/125-0 Fax: +49 7157/125-120 www.telegartner.com

a	20905	27.05.09	BM	2008	Datum/ date	Name/ name	Gewicht/ weight	Oberfläche/ surface	Werkstoff/ material
				gez./ drawn	05.11.08	BM	[g]	[mm²]	
				gepr./ appr.	01.12.08	HI			Oberfläche/ finish
				Norm/ stand.					
				Maßstab/ scale	Benennung/ title				 <b>Telegärtner</b>
				<b>Anschlussdose / Outlet</b> <b>AMJ45 8/8 UP/50 Cat.5e</b>					
				untol. Maße/ dim. without tolerances	Unterf./doc. type	Zeichnungsnr./ drawing no.		 Maße/ dimensions: mm	
				according to	<b>D</b>	<b>J00020A0389</b>			
Änd./ rev. index	Änderungsmittelung/ revision code	Datum/ date	Name/ name	Ersatz für/ replaces				Original : DIN A4	
								Blatt/ sheet 2 von/ of 3	

Alle Rechte vorbehalten / all rights reserved © Telegärtner K.Gärtner GmbH D-71144 Steinbronn Leichenstrasse 35 Germany Phone: +49 7157/125-0 Fax: +49 7157/125-120 www.telegartner.com

<b>Übertragungstechnische Eigenschaften</b>		<b>Transmission Performance</b>
Gigabit Ethernet gemäß IEEE 802.3af	geeignet für Gigabit Ethernet Adequate for Gigabit Ethernet	Gigabit Ethernet acc. to IEEE 802.3af
Cat.5e	ISO/IEC 11801:2002, EN 50173-1:2007	Cat.5e
<b>Normen</b>		<b>Standards</b>
Anwendungsneutrale Kommunikationskabelanlagen	ANSI/TIA/EIA-568A ISO/IEC 11801:2002, EN 50173-1:2007	Generic cabling systems

	20905	27.05.09	BM	2008	Datum/ date	Name/ name	Gewicht/ weight	Oberfläche/ surface	Werkstoff/ material
				gez./ drawn	05.11.08	BM	[g]	[mm <sup>2</sup> ]	
				gepr./ appr.	01.12.08	HI			Oberfläche/ finish
				Norm/ stand.					
				Maßstab/ scale	Benennung/ title				 <b>Telegärtner</b>
					<b>Anschlussdose / Outlet</b> <b>AMJ45 8/8 UP/50 Cat.5e</b>				
				untol. Maße/ dim. without tolerances	Unterf./doc. type	Zeichnungsnr./ drawing no.		 Maße/ dimensions: mm	
				according to	<b>D</b>	<b>J00020A0389</b>			Original : DIN A4
Änd./ rev. index	Änderungsmittelung/ revision code	Datum/ date	Name/ name	Ersatz für/ replaces					Blatt/ sheet 3 von/ of 3